

Instruction Manual

Studio flash **Quantum DP-300/DP-600**

Foreword

Thank you for purchasing the Quantum flash.

Quantum DP-300/DP-600 series are mainly designed for photographers who need flash light, which could be used inside and outside the studio. The greatest feature of these flashes is the possibility of supplying them with traditional electrical network or with **Quantum DP-6** battery which could be bought separately. Thanks to this solution **Quantum DP** strobes enable comfortable work and usage either in studios and facilities that lack electrical installation.

Basic features of Quantum DP flash:

- powered by AC power source or with **Quantum DP-6** battery (available separately)
- smooth flash power adjustment (up to 1/16)
- short recycling time (aprox. 1,5 sec, with full flash volume and AC supply)
- short flash duration 1/1500s (with 1/16 of power, $t=0.5$)
- high output stability and color temperature (5600K)
- 150W modeling lamp
- built-in cooling fan
- flash triggering through through 6.3mm Jack socket and slave controller
- Bowens mount

Please read the instruction manual carefully before using this product. It includes important information about safety, usage and maintenance of the product. By implementation of guidance included in instruction manual allows full exploitation of its possibilities.

















Please keep this instruction manual for future reference in a known location and easily accessible to all users of the device.

Table of contents

| | |
|------------------------------------------------------------|---|
| Foreword..... | 1 |
| Basic features of Quantum DP flash:..... | 1 |
| Safety instructions..... | 2 |
| Names of parts..... | 3 |
| Supplied accessories..... | 4 |
| Optional accessories..... | 4 |
| Handling and usage..... | 4 |
| Flash preparation..... | 5 |
| Fixing the light modifiers..... | 5 |
| Work with the flash powered form AC power source..... | 5 |
| Connecting the power source..... | 5 |
| Modeling light..... | 5 |
| Flash light..... | 5 |
| Test flash..... | 5 |
| Sync socket..... | 6 |
| Slave triggering..... | 6 |
| Sound signal..... | 6 |
| Work with the flash powered from Quantum DP-6 battery..... | 6 |
| Flash tube replacement..... | 6 |
| Maintenance..... | 7 |
| Technical Data..... | 7 |

Safety instructions

To avoid the device damage and also threat to health of its users it is an obligation to read thoroughly the manual instruction and absolutely obey the rules included.

-  Do not disassemble and modify the device! The flash is high voltage device. Even after disconnecting the device from power source and turning it off, inside its internal components still occurs high-voltage current. Disassembling of the cover can be performed only by the authorized Quantum service. Ignoring above-mentioned safety instructions could result in serious electric shock or the device damage. Modifications of the device at one's own or by unauthorized service results in warranty void.
-  If the cover is damaged, eg. in consequences of falling, it is advised to send the device to authorized service center for inspection and repair (if necessary).
-  Keep it dry! Do not use the device with wet hands, do not immerse in water, do not expose to snow or rain. Ignoring above mentioned safety instructions could result with electric shock, short circuit of fire.
-  Flash is designed to work in temperature from 10 to 40 Celsius degrees. Exceeding this scope could result in incorrect functioning of the device or could lead to overheat and damage.
-  Do not expose the device on high temperatures! Leaving the device without proper protection for example left in a closed car in direct sunlight or close to high temperature sources could result in fire, damage of the cover or internal components.
-  The device must not be used in high dustiness conditions and when there is a risk of contact with flammable liquids and vapors. Disobeying given advice results in the device damage or fire.
-  Flash is designated to function and to be stored in dry and well ventilated closed spaces.
-  After 30 subsequent flashes with full power, it is advised to make a 3 minute break to cool down flash bulb and lamp internal components. Disobeying given advice results in overheating the device.
-  Long-term usage of modeling light may cause combustion of attached accessories, eg. the softbox. It is advised to make 1 minute break to cool down the flash bulb and internal components for every 10 minutes of functioning modeling light.
-  Do not attach filters, diffusers or any other accessories directly on the flash head, modeling light bulb or nearby because it could cause a fire.
-  Using accessories like snoot, it is advised to limit the usage of modeling light and limit the flashes (below 6 flashes per minute). Overheating could result in the zoom head of the flash or modeling illumination damage.
-  Do not touch the reflector while using the modeling illumination or flashing. Emitted heat could cause burnings.
-  Touching output terminal of the zoom head of the flash could result in high-voltage electric shock! Replacement of the zoom head of the flash may be done only after self-discharge of the flash. It is necessary to wait minimum 24hours since the last usage of the flash before the procedure of replacement. It is advised to use insulated gloves. Disobeying given advice could result in the device damage or electric shock.
-  Avoid applying forces which may damage the zoom head of the flash or modeling illumination bulb. Sudden impact could lead to the zoom head or/and light bulb damage.
-  Do not trigger the flash directly on unprotected eyes. Disobeying given advice could result in sight injury.
-  Keep out of the reach of children! The flash contains small parts which may pose the risk of suffocation. If swallowed, seek medical advice immediately.

The manufacturer does not take responsibility for any damage or injury which may occur while using inconsistently to the given manual instruction.

Names of parts

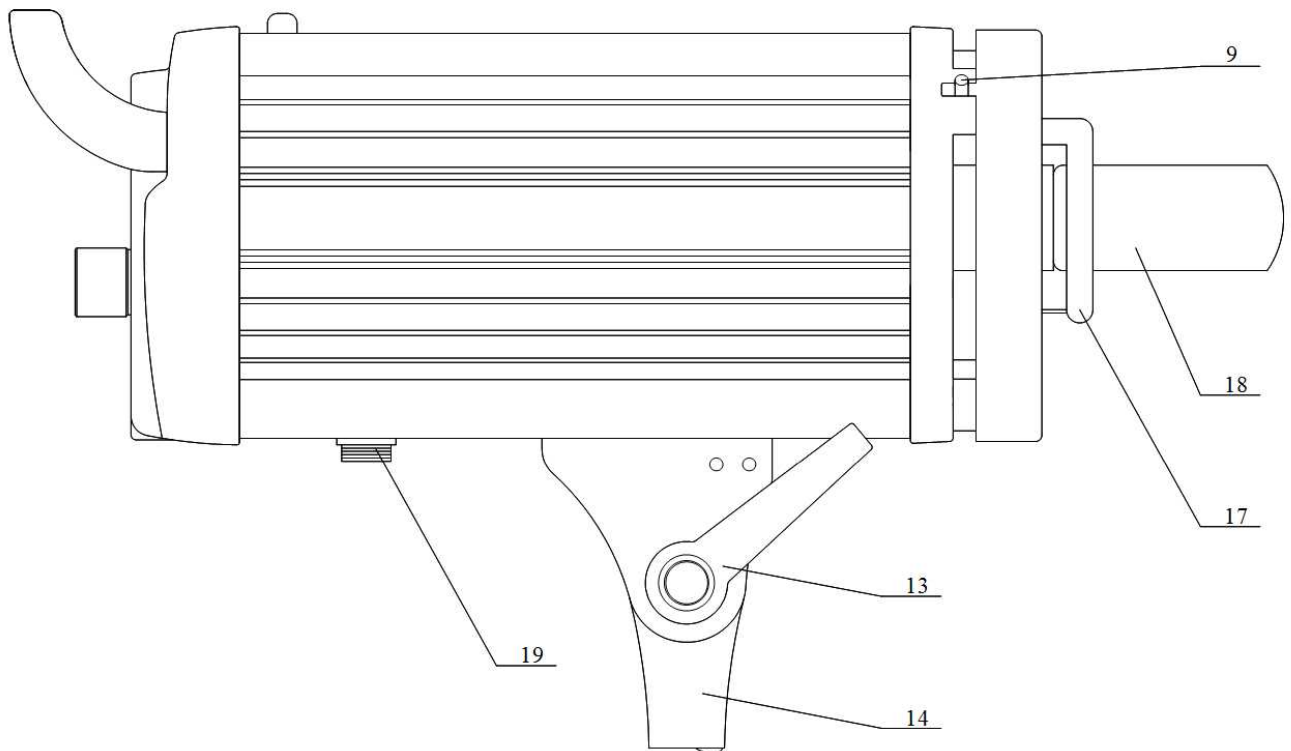
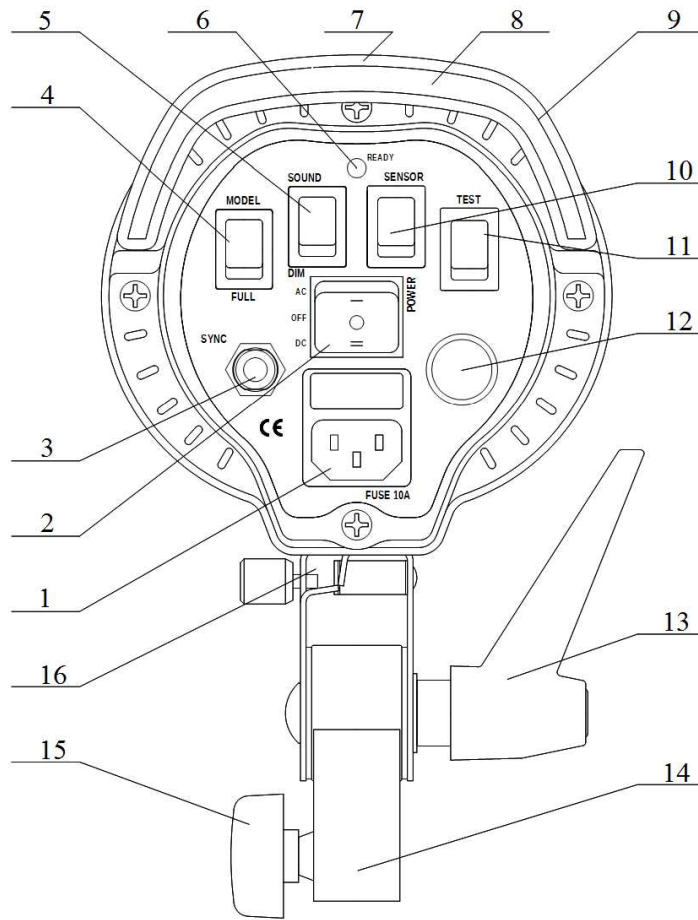

- | | |
|-------------------------------------------------|--------------------------------------------|
| (1) Power socket (AC) | (11) TEST – test flash firing switch |
| (2) POWER – flash switch/ power switch | (12) Flash power/modeling light controller |
| (3) SYNC – sync cord or wireless trigger socket | (13) Flash direction clamp |
| (4) MODEL – modeling light control switch | (14) Tripod holder |
| (5) SOUND – sound signal switch | (15) Tripod holder clamp |
| (6) READY – device operation indicator | (16) Umbrella holder |
| (7) Slave Flash Controller | (17) Flash bulb |
| (8) Flash handle | (18) Modeling light bulb |
| (9) Light modifier bayonet locker | (19) Battery power socket (DC) |
| (10) SENSOR – Slave trigger switch | |

Supplied accessories

The flash is supplied with following accessories:

1. Power cord
2. Sync cord
3. Flash bulb cover
4. Modeling light bulb
5. 7" reflector
6. Instruction manual

Optional accessories

The flash can be used with separately sold **Quantum DP-6** battery, which enables comfortable work and usage in facilities that lack electrical installation. The flash is compatible with separately available equipment like the **Quantum** light modifiers and products of other independent manufacturers which are equipped with Bowens type bayonet.

Handling and usage

Before connecting the flash to the AC power source, please check the parameters of supplied electric current (200 ~ 240V 50Hz) and make sure that the electrical installation is in good technical condition. You should immediately stop using the flash if it is suspected that the electrical installation does not meet requirements or is not in good condition.

- 1) To keep the flash functioning safely, the device should only be plugged in the earthed socket.
- 2) It is forbidden to use any portable source of energy other than **Quantum DP-6** battery or **Quantum Leadpower LP-750** inverter. It is unacceptable to use power generators. Disobeying the given advice may cause the device damage.
- 3) Flash cannot be connected to AC power source and battery at the same time! The battery could be connected with the device only if the power switch (2) is turned on 0 position and there is no connection between the device and power cord. Connecting flash to electric installation can be done only when battery is disconnected completely.
- 4) The flash cannot be used in high humidity conditions; its cover is neither splash nor water proof. The flash must be protected from humidity and water.
- 5) It is prohibited to cover and to place any objects on the vents because it might lead to device overheating or permanent damage.
- 6) It is not allowed to touch the flash bulb (17) and the modeling light bulb (18) – it may cause their damage or early wear. Damaged flash bulb or modeling light bulb pose a risk of electric shock. It is advised to stop using the flash if the flash bulb or modeling light bulb is damaged till the time of its replacement by the new one.
- 7) The flash should not be left turned on if it is not in use.
- 8) The flash is equipped with overheating protection which starts up when flash is triggered too frequently. In this case the flash will automatically turned on cooling mode which is indicated by a long single sound signal. During this mode it is impossible to trigger a flash. Do not turn off the flash! Built-in cooling fan is functioning only when connected to power source.
- 9) The flash is equipped with warning alert system indicating malfunction. When any part of the flash is working properly, warning alert is indicated by short subsequent sound signals. In this case the flash must be turned off and disconnected from power sources. It is advised to wait till cooled down and then turn on the device. If the situation happens again, immediately contact the authorized Quantum service center.

Disobeying the given advice may result in device damage!

Flash preparation

1. Disassemble the cover of the z flash bulb and attach the modeling light bulb (18).
2. Fix the device on suitable studio tripod using tripod holder (14), adjust direction of flash and tighten the clamp (13).

Fixing the light modifiers

1. Adjust the pins of light modifier bayonet with openings founded on the flange placed in front of the flash.
2. Turn the modifier mount clockwise till the click of locking mechanism.
3. To take off the modifier pull the light modifier bayonet locker (9) which is placed on the top of flash cover. After that turn the modifier mount ring counter-clockwise and disconnect it from lamp bayonet.
4. To attach umbrella to umbrella holder (16). Before the installation fix the flash cover (included in supplied accessories) in a way that its opening corresponds with umbrella holder clamp. After slipping umbrella into the holder, tighten the locking screw.

During the process of assembly/ disassembly of light modifiers it is essential to keep extreme caution. It is recommended to conduct these activities when the flash is turned off. Touching the flash bulb (17) and modeling light bulb (18) should be avoided because during their work they reach high temperatures and the direct contact may cause burnings or their damage.

Work with the flash powered form AC power source

Connecting the power source

1. Use the power cord which is included in supplied accessories to connect the device with the AC power source 200~240V 50Hz (the socket must be equipped in earth pin) to the power socket (1). Before connecting the power cord check if power switch (2) is in the OFF position.



CAUTION!

Power switch (2) has three positions:

OFF – device turned off,

AC – AC power supply,

DC – battery power supply

Connecting the power cord should take place only when the switch is in the OFF position. Disobeying this advice may cause the device damage.

2. After connecting the power cord turn the power switch (2) on AC position. The flash indicates ready to operation status by lighting up the READY diode (6). Turning the switch on DC position does not start up the device.

Modeling light

Modeling light is helpful to estimate amount of light and its distribution on the photographed object. Modeling light switch (4) could be set in three modes:

- Turned off (0 position)
- Proportional to adjusted flash power (I position)
- Full power (II position).

After turning the SOUND switch (5) on DIM position, the flash turns off the modeling light during the flash time. Once charged, the lamp will light up again, which indicates device readiness for next flash.

Flash light

Flash power controller knob (12) allows to adjust the flash power output. It enables adjusting flash power to the light conditions and user's individual needs. Flash power could be adjusted from 1/1 to 1/16. After changing flash power from higher to lower level, the lamp will trigger automatically to dump excess power and to adjust the flash power level, to the point which is on the knob.

Test flash

Press the test flash switch (11) to trigger the flash without taking a photo. The mentioned function is also helpful when the user wants to adjust the flash power using the flash power controller (12).

Sync socket

Sync cord, which is a part of set, has a 6,3mm diameter Jack plug (3). To synchronize flash with camera shutter, one end of cord should be plugged in the sync socket which is placed on the flash back panel (3) and the second end plugged in the camera. It is necessary to adjust the shutter time according to the camera manufacturer's advice, in other way the photo exposure might be incorrect. It is also possible to connect different remote flash triggers, which are available separately, to the sync socket.

Slave triggering

Built-in to the lamp slave trigger (7) allows to trigger the flash without the necessity of connection by sync cord or additional remote trigger. SENSOR switch (10), which controls the work of slave trigger, has two positions: turn on [1], turn off [0]. On [1] position the flash would react on flash from another lamp and it would trigger the flash.

Intensive outside lightning on slave trigger e.g. direct sunlight, may disrupt its proper operation. It is not a malfunction but a normal circumstance. The flash would not react on the o flash from another device. To avoid this it is necessary to place the device in shade area or where intensive direct lightening would not occur on slave trigger.

Sound signal

Sound signal switch (5) allows control of readiness to work notification. When the switch is on [1] position the sound signal would occur in case of full charge of the device. Position [0] is mute the sound.

Work with the flash powered from Quantum DP-6 battery

One of the basic features of Quantum DP-300/DP-6 flash is the possibility of supplying with AC power source or with separately sold Quantum DP-6 battery. Thanks to this solution Quantum DP strobes enable comfortable work and usage either in studios and facilities that lack electrical installation. To use the Quantum DP-6 battery as a source of power for Quantum DP strobes You must do the following:

1. Before connecting the flash to the battery make sure that the flash and battery are turned off (both switches on OFF position) and disconnected from the AC power source.
2. Next, plug in the cord connecting the flash with the battery (the cord is supplied with the battery) and tighten locking pin.
3. Turn on the battery power supply by turning the switch on BATT (placed on battery panel).
4. After turning on the battery, choose the battery as a power supply by turning the POWER switch (2) placed on rear flash panel to DC position.
5. To make sure that the flash is correctly connected it is advised to trigger the flash with TEST switch (11).

During flash recycling red diode is shining on the battery control panel. It is not possible to use modeling light when the flash is powered form **Quantum DP-6** battery. Modeling bulb is automatically switched off after changing POWER switch (2) to DC position.

Cooling fan, which is built-in the flash cover, does not work when the flash is supplied from the battery. In this case it is recommended do limit frequency and flash power to avoid the device overheating.

During the intensive usage the battery may heat up. It is advised not to take more than 6 flashes consecutively. More details about the **Quantum DP-6** battery and instructions how to work with the device are included in attached instruction manual.



CAUTION!

It is forbidden to connect the power cord and the battery at the same time.
It is forbidden to connect the battery to the flash and using it during the charging process.
Disobeying the given advice may cause both devices damage.

Flash tube replacement

The construction of **Quantum DP-300/DP600** flashes allows replacement of flash tube by the user himself. To perform the replacement operation you need to:

1. Turn off the flash by changing the switch (2) to OFF position.
2. Disconnect the power supply by plugging off the cords from AC power source or battery.
3. Wait minimum 24 hours since the last usage, till the flash is cooled down and the discharged.
4. Using dry cloth or glove unscrew the modeling light bulb (18) and then carefully pull out and take out the flash tube (17).
5. The flash tube and the modeling light bulb should be assembled in reverse order and by keeping the

given instructions.

Leaving fingerprints or any other dirt on modeling light bulb or flash tube may cause shortage of their work time. It is recommended to use insulated gloves during the replacement of modeling light bulb and flash tube.



CAUTION!

It is forbidden to use flash tubes other than supplied by **Quantum**. Replacement of the flash tube should be performed after minimum 24 hours since the last usage of the flash. Short circuited of the charged strobe flash tube contact pins may cause rapid and uncontrolled discharge of energy stored in the lamp which may result in device damage and high-voltage electric shock.

Maintenance

1. Immediately turn off the device in case of inappropriate working or suspicion that the flash cover or the power cord is damaged.
2. The flash must be protected from sudden impact, hits and dirt and dust. Cover should be clean.
3. The flash may heat up during work. It is normal, especially when the flash is often triggered and works on maximum flash power and modeling light.
4. Flash tube and the modeling light bulb are consumable parts which may be replaced by the user himself. The warranty on these elements is valid for 3 months.
5. Repair, maintenance and cleaning of internal elements of the flash should be performed by the authorized **Quantum** service. Modifications of the device by the user or by unauthorized service results in warranty void.
6. It is forbidden to use the flash in case of risk of being damaged, dusted or moisten. In this situation it is required to contact the authorized **Quantum** service immediately.
7. It is necessary to disconnect the flash from power source and wait till its internal components and flash tube are completely cool down before moving from one place to another.
8. Cleaning the flash cover may only be performed after turning off, disconnecting from power supply and complete discharging. It is required to wait minimum 24 hours since the last usage of the flash before cleaning.

Technical Data

| | | |
|-------------------------------|---------------------------------------|--------------------|
| Flash power: | 300Ws | 600Ws |
| Guide Number (ISO 100): | 54m | 78m |
| Flash Duration (t=0.5) | 1/1500s - 1/800s | |
| Cooling: | active, built-in fan | |
| Flash Power Control: | 1/1-1/32 | |
| Recycle Time (at full power): | <1,5s AC <2,5s DC | <3s AC <5,5s DC |
| Modeling light: | E27 halogen bulb 150W/240V/50Hz | |
| Flash Color Temperature: | 5600K | |
| Triggering Method: | Test button, Sync cord, Slave trigger | |
| Fuse: | 10A | |
| AC Power Input: | 200~240V 50Hz | |
| Dimensions: | 136x127x300mm | |
| Weight: | 2.2kg | 2.7kg |

Made in China

